

Deep Branch Type M&P Box for 25 & 40 kVA D.T.
(TN-2137)

RH SIDE VIEW

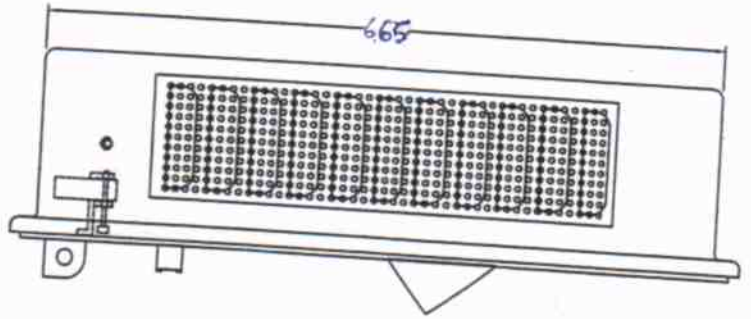

ELEVATION WHEN DOOR CLOSED

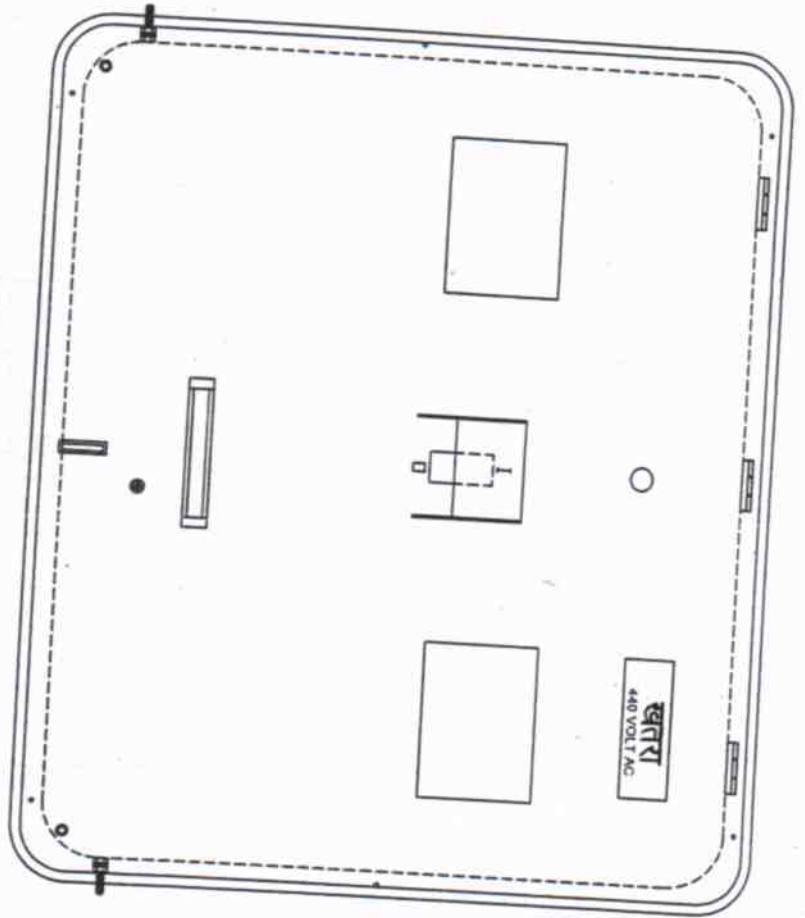

LH SIDE VIEW

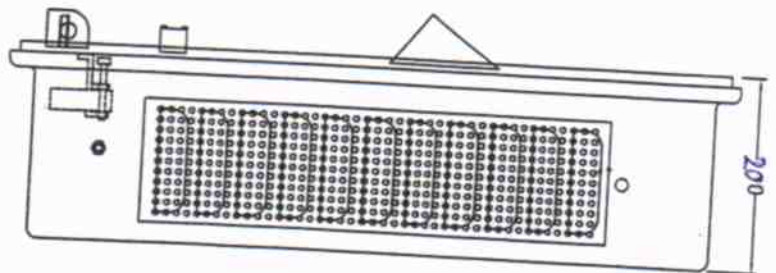

BOTTOM VIEW

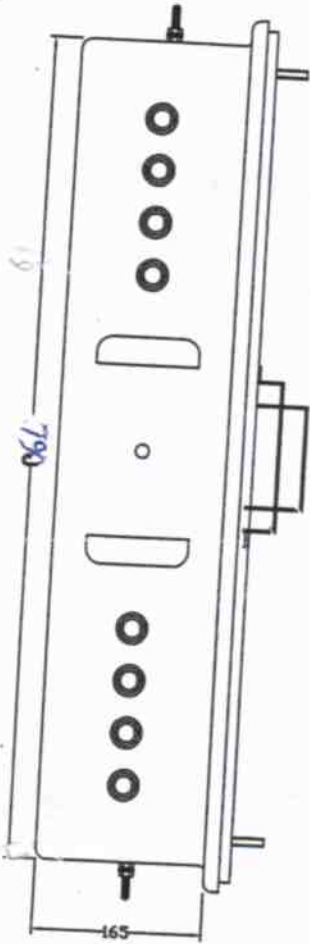

* METER CUM PROTECTION BOX *

BACK VIEW

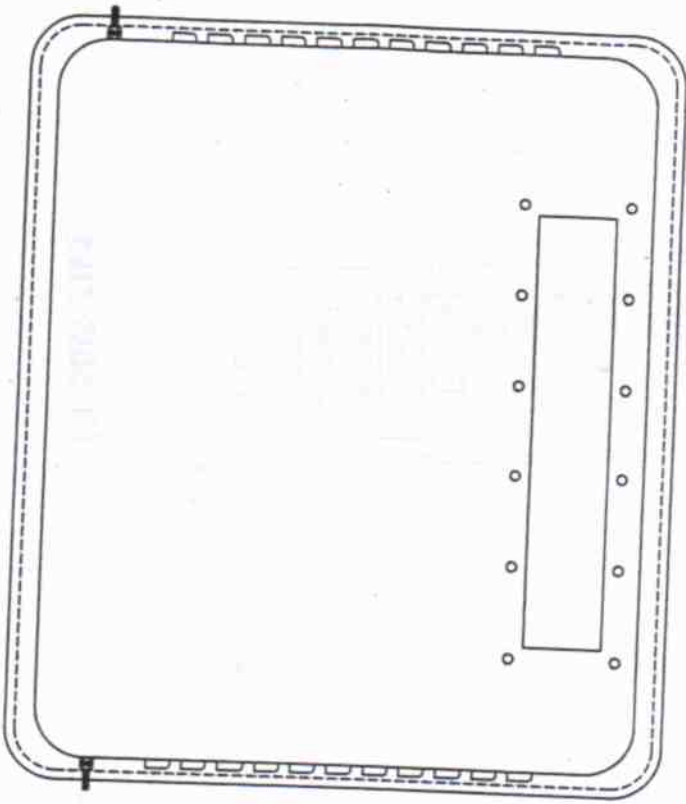

ELEVATION WHEN DOOR OPENED

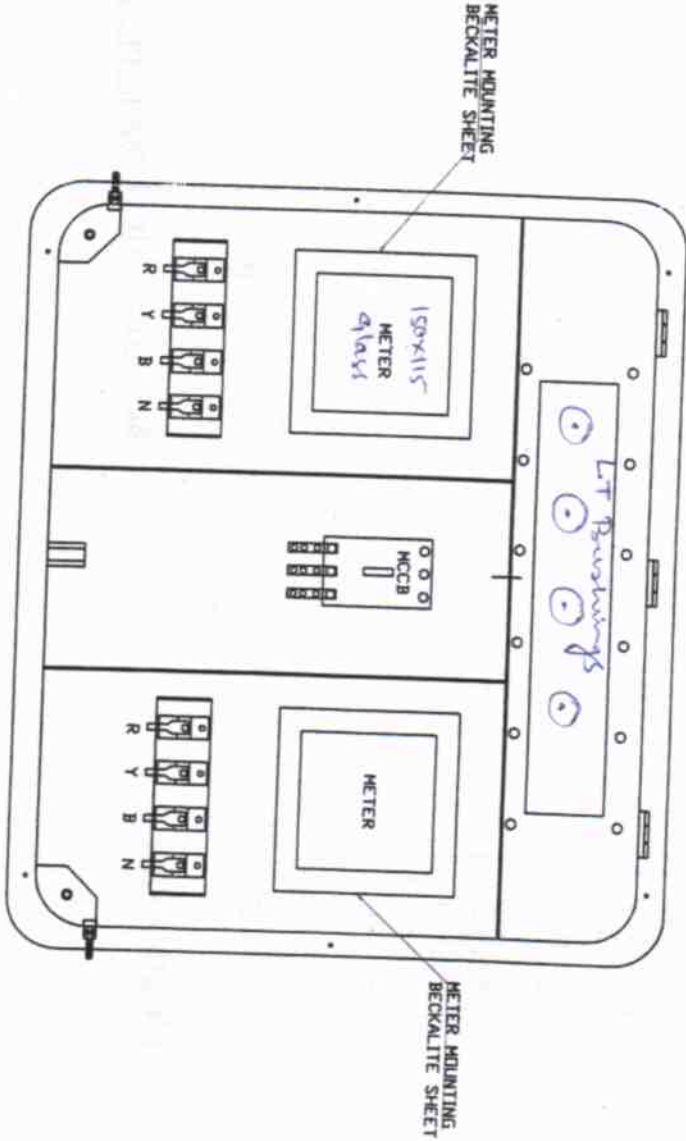

M&P Box for 25KVA & 40KVA D.T. (TN-2137)

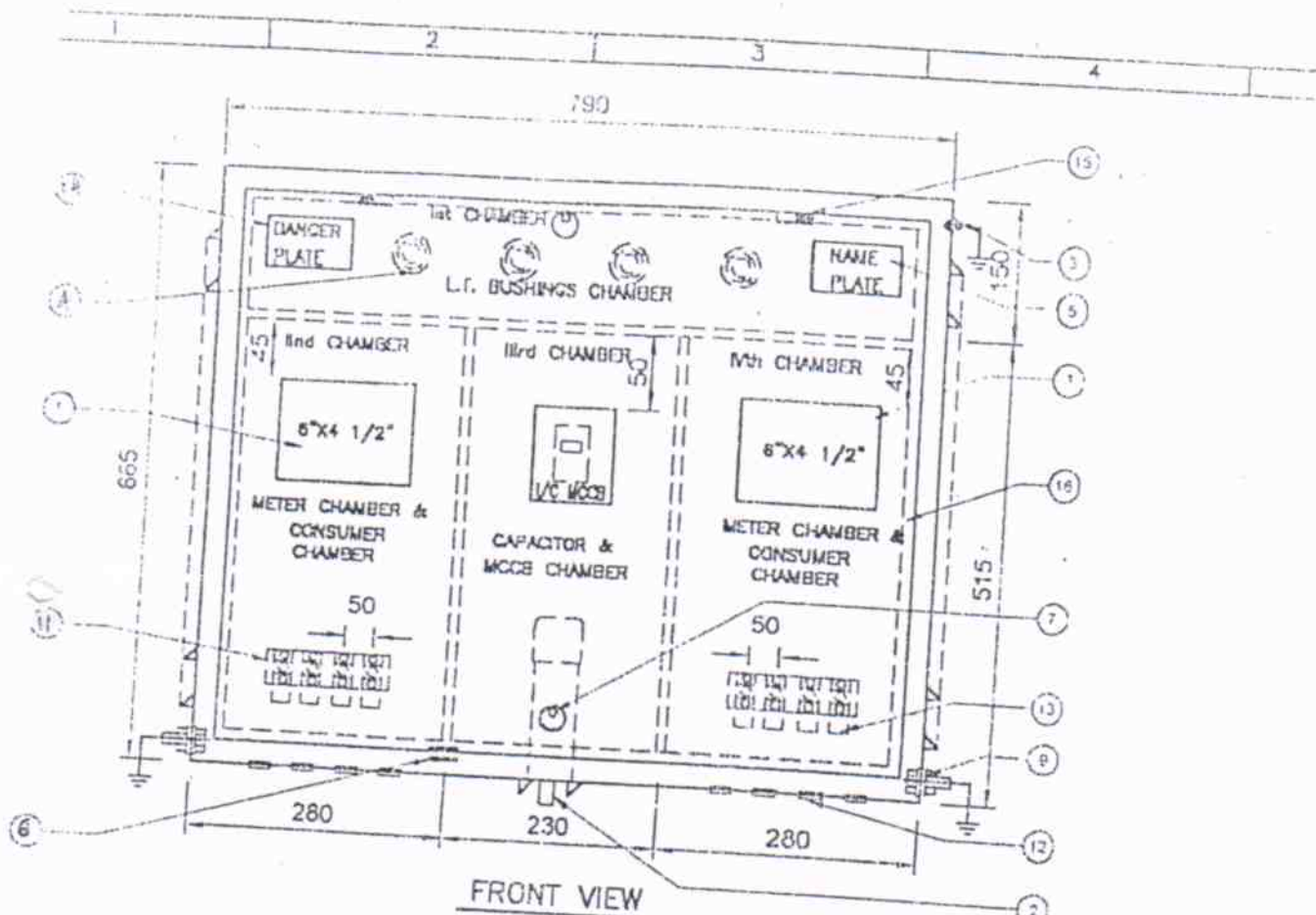

FRONT VIEW

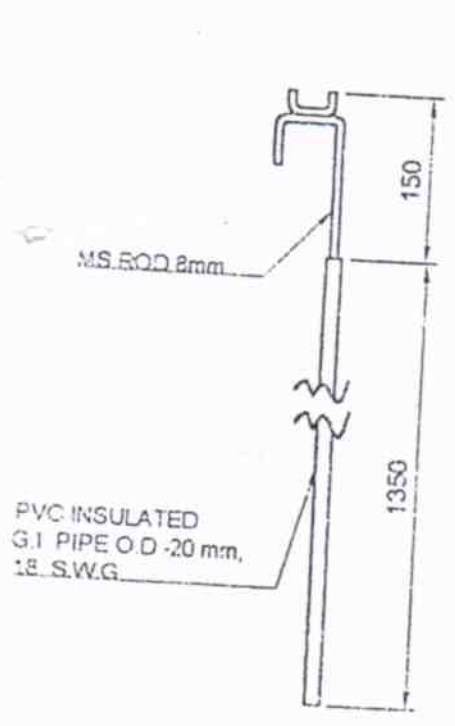

OPERATING ROD

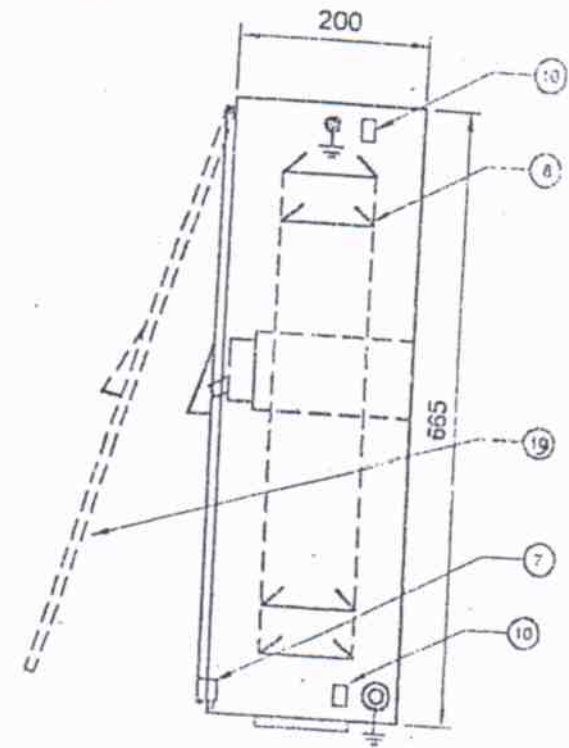

SIDE VIEW