



TENDER REF. : TN-2111

100 mm	
L.T. DISTRIBUTION KIOSK	
COUNTRY : INDIA	ISS REF. : 8623
POLE :	
RATED VOLTAGE : 415 V, A.C., 50 HZ	
DISTRIBUTION KIOSK RATING	
TOTAL NO. OF INCOMING CIRCUIT	
TOTAL NO. OF OUTGOING CIRCUIT	
RATED CURRENT INCOMING CKT.	
RATED CURRENT OUTGOING CKT.	
NAME OF PURCHASER	
J.V.V.N.L.	
ORDER NUMBER	JPD/SE/MM/SPO-V/TN- PO- Dt-
DATE OF DISPATCH	

 	
7 mm	

Hole Size : Ø 4mm

L.T. DISTRIBUTION KIOSK

A. S.
S.

P.O. NO.: JPD / SE (MM) / SPO-V / TN-2111	
TITLE: DANGER PLATE FOR L.T. DISTRIBUTION KIOSK	DATE
DRG. NO.	

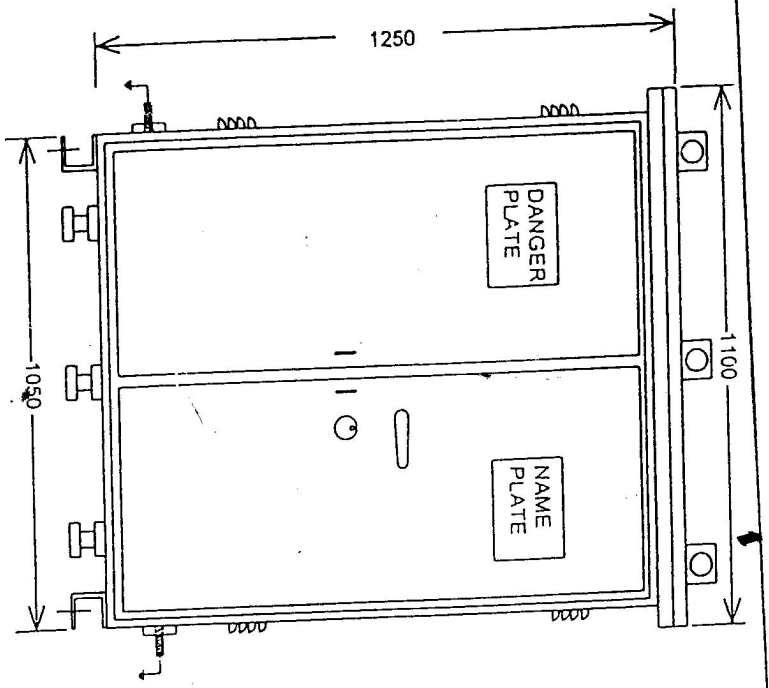

**FRONT - VIEW
WITH DOOR**

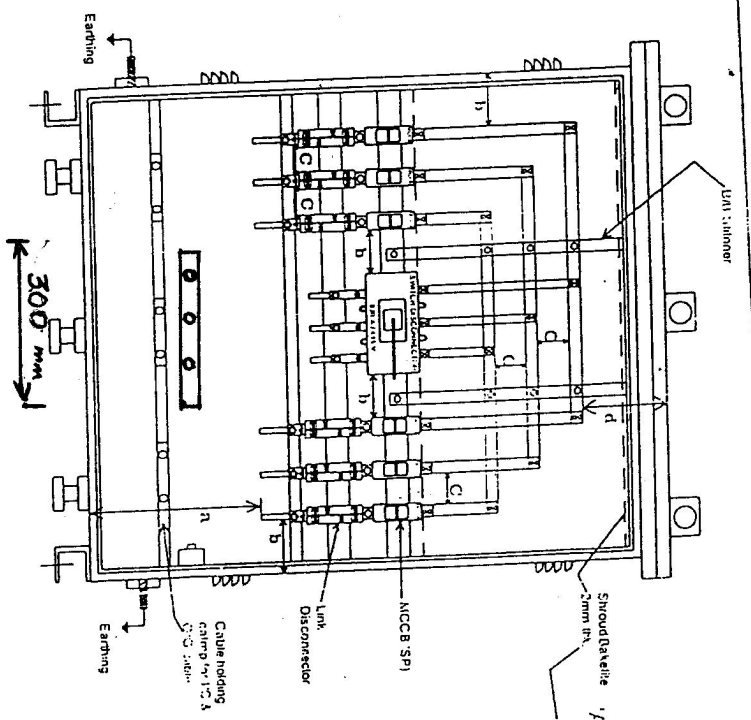

**FRONT - VIEW
WITHOUT DOOR**

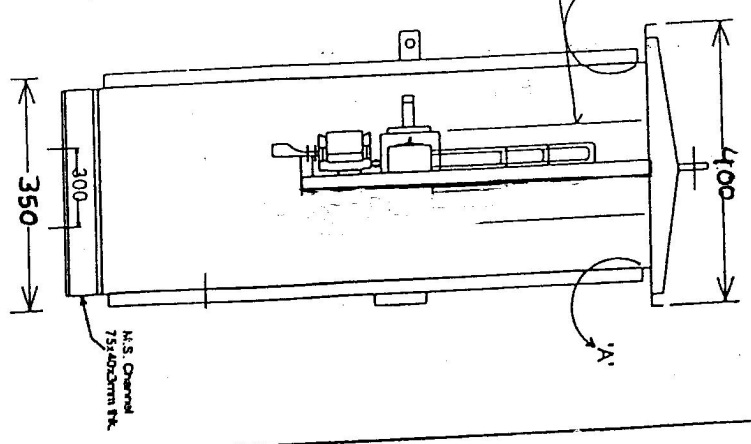

SIDE VIEW

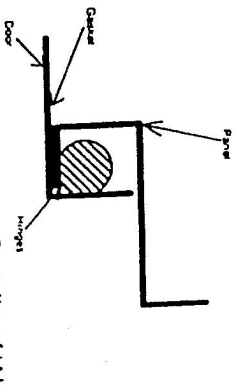

**Details of 'A'
HINGES ASSEMBLY**

Handwritten signature and arrow pointing right.

Handwritten signature and arrow pointing right.

1. All dimensions are in mm.
Sheet - 1/2 **SE (M M) / 5 DO - II / TN - 2111**

JAIIPUR VIDYUT VITRAN NIGAM LIMITED

**L.T. DISTRIBUTION KIOSK FOR
63/100 KVA TRANSFORMERS.**

TITLE

200 mm

खतरा

415

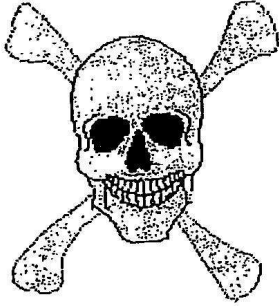

VOLTS

BOLT HOLES 7 MM DIA FOR 6 MM DIA G.I. BOLTS

15

150 mm

15

DANGER

जयपुर विद्युत वितरण निगम लिमिटेड

WHERE EVER NOT MENTIONED DIMENSIONS ARE IN mm.

SPECIFICATION OF THE DANGER BOARD

- 1) MATERIAL : M.S. SHEET
- 2) SIZE : 150 X 200 MM
- 3) FRONT SIDE : BACKGROUND ENAMELED WHITE.
LETTERS, FIGURES, CONVENTIONAL/SKULL AND BONES
IN SIGNAL RED COLOUR.
- 4) BOLT HOLES : 2 NOS. 7 MM DIA FOR 6 MM DIA G.I. BOLTS.

P.O. NO.: JPD/SE(MM)/SPO-V/TN 2111		
TITLE: DANGER PLATE FOR L.T. DISTRIBUTION KIOSK	DATE	
DRG. NO.		NOT TO SCALE

Handwritten signatures and initials.